

YOUR SOLUTION PARTNER IN
INDUSTRIAL
VALVE AUTOMATION...

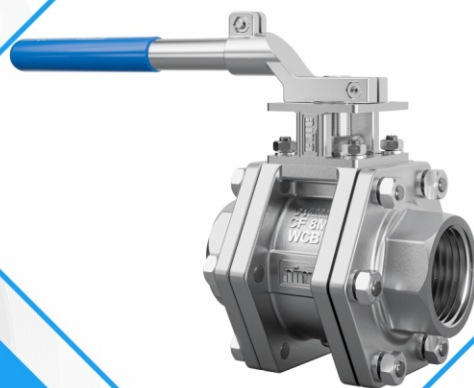

HBA HIGH PRESSURE SCREWED BALL VALVE



APPROVALS



WEBSITE



Mfg. & Mkt by :

aira Euro automation pvt. ltd.

Ahmedabad-382405, INDIA.

www.airaindia.com





About Us

We welcome and thank you for referring out detailed catalogue.

aira is know all over continents as a manufacturer of quality products - Ball Valves, Butterfly Valves, Plug Valves, & Control On / Off Valves with Pneumatic Actuators for Pharma, Oil & Gas, Steel, Paper, Water, Chemical and all type of processing industries.

aira has walked through more than 3 decades, gaining valuable experience, offering equipment's in the products manufactured by OEMs in all spheres of engineering.

aira products have gained reputations of consultants, and approvals of users, OEMs and other as a quality product.

aira has expanding business into foreign markets specially GCC, UAE, Asian & African countries. This is because increase its customer base and revenue, leading to overall growth and success. Now foreign users come to know and believe in the services provided by the **aira**. Along with the same, it also helps to reach a large number of users thereby leading to the increase their business.

Being and ISO 9001 BVQI certified company has put **aira** in fore front. Out motto is "Value the customer" and "Superior product", one among the best in the world.

Clients are why we exist!

Our Quality

- In- House full scale testing facility.
- Lean manufacturing practices
- Certified by : ISO 9001 : 2015 (BVQI LONDON), CE, ATEX, CIMFR, BIS, PESO, SIL 3, IBR
- API 609, API 6D

Our Commitment

- To understand customer's need first before proposing our products.
- To keep on providing competitive rate's by adapting to continuous process improvement, without compromising on quality.
- To provide continuous support to our customers and go beyond their expectations in terms of delivery and after sale services.

Our Manufacturing Facility

- In house R & D, manufacturing and testing facility is all located in a spread over three campuses at Ahmedabad, Gujarat, INDIA.

Network - Sales Office

- 60 Plus Branch Offices in different states in India.
- Sales office in the Bangladesh, Dubai, Kenya, Malaysia, Nepal, Qatar, Singapore, South Africa, Sri Lanka, Turkey, USA (Expanding).

SIL 3 CERTIFICATIONS

CE CERTIFICATE

Certificate / Certificat
Zertifikat / 合格証

AEA 1902082 C001
exida hereby confirms that the:

Pneumatic Rotary Actuator
Aira Euro Automation Pvt Ltd
Ahmedabad - India

Has been assessed per the relevant requirements of:
IEC 61508 : 2010 Parts 1-7
and meets requirements providing a level of integrity to:
Systematic Capability: SC 3 (SIL 3 Capable)
Random Capability: Type A, Route 2_g, Device FFH/FFD_{gg} and Architecture Constraints must be verified for each application

Safety Function:
The Actuator will move the attached Valve to the designed safe position per the Actuator design within the specified safety time.

Application Restrictions:
The unit must be properly designed into a Safety Instrumented Function per the Safety Manual requirements.

Revision: 1.0 Dec 24, 2019
Surveillance Audit Due: Jan 01, 2023

Evaluating Assessor: *[Signature]*
Certifying Assessor: *[Signature]*

IAF ANSI SIL 3 CAPABLE

SIL 3 - PNEUMATIC ROTARY ACTUATORS

Certificate / Certificat
Zertifikat / 合格証

AEA 1902082 C002
exida hereby confirms that the:

Double Eccentric Butterfly Valve
Aira Euro Automation Pvt Ltd
Ahmedabad - India

Has been assessed per the relevant requirements of:
IEC 61508 : 2010 Parts 1-7
and meets requirements providing a level of integrity to:
Systematic Capability: SC 3 (SIL 3 Capable)
Random Capability: Type A, Route 2_g, Device FFH/FFD_{gg} and Architecture Constraints must be verified for each application

Safety Function:
The Butterfly Valve will move to the designed safe position per the actuator design within the specified safety time.

Application Restrictions:
The unit must be properly designed into a Safety Instrumented Function per the Safety Manual requirements.

Revision: 1.0 Dec 24, 2019
Surveillance Audit Due: Jan 01, 2023

Evaluating Assessor: *[Signature]*
Certifying Assessor: *[Signature]*

IAF ANSI SIL 3 CAPABLE

Page 1 of 2

SIL 3 - BUTTERFLY VALVE

EURO CERT

Certificate No. 18-07-1186
Date of issue: 04/04/2021
Valid from: 04/04/2021
The Certificate is valid until: 04/04/2024
Subject to satisfactory annual surveillance

CERTIFICATE OF FULL QUALITY ASSURANCE FOR PRESSURE EQUIPMENT ACCORDING TO EUROPEAN DIRECTIVE 2014/68/EU (MODULE H)

Applicant/Manufacturer (Name & Address): AIRA EURO AUTOMATION PVT. LTD., PLOT NO. 125-126, AIRA ESTATE, BHM SECURITY ESTATE, NEAR KASHIMIR TEXTILE MILL, AHMEDABAD, GUJARAT, INDIA.

Type of Pressure Equipment: INDUSTRIAL BUTTERFLY VALVES

Technical Description of Pressure Equipment: Access to this certificate

Technical Category of Pressure Equipment: 01

Against the Provisions of: EUROPEAN PRESSURE EQUIPMENT DIRECTIVE 2014/68/EU, ANNEX I, PART 1, SECTION 1.2, DESIGN, PRODUCTION, FINAL INSPECTION AND TESTING OF PRESSURE EQUIPMENT

Scale of Certification: FROM 200T TO 2000BAR

Scale Report No.: FROM 200T TO 2000BAR

Conditions & Exclusions: Each piece of equipment should be accompanied with manufacturer's Declaration of conformity and instructions of use. The manufacturer must keep the notified body informed of any extended operation of the quality assurance system. The manufacturer must affix the CE Marking and Eurocert's Identification No. to each item of pressure equipment at the time of final inspection.

CE

This is to certify that Eurocert S.A. has assessed the quality assurance system of the above-mentioned manufacturer with satisfactory results.

CE - BUTTERFLY VALVE

ISO CERTIFICATIONS

CERTIFICATE **dqs**

This is to certify that:

AIRA EURO AUTOMATION PVT. LTD.
Plot No. 125-126, Aira Estate, BHM Security Estate, Near Kashmir Textile Mill, Ahmedabad - 382 405, Gujarat, India

has implemented and maintains an Environmental Management System.

Scope: Equipment activities and supporting processes associated with the Design, Manufacture, Marketing and Dispatch of Industrial Valves.

Through an audit, documented in a report, it was verified that the management system fulfils the requirements of the following standard:

ISO 14001 : 2015

Certificate registration no.: 9022088-0015
Date of original certification: 2019-03-10
Date of review: 2021-09-03
Date of recertification: 2023-09-03
Valid until: 2025-09-03

DQS Inc. *[Signature]*

IAF

ISO 14001 : 2015

CERTIFICATE **dqs**

This is to certify that:

AIRA EURO AUTOMATION PVT. LTD.
Plot No. 125-126, Aira Estate, BHM Security Estate, Near Kashmir Textile Mill, Ahmedabad - 382 405, Gujarat, India

has implemented and maintains an Occupational Health and Safety Management System.

Scope: Occupational Health and Safety activities and supporting processes associated with the Design, Manufacture, Marketing and Dispatch of Industrial Valves.

Through an audit, documented in a report, it was verified that the management system fulfils the requirements of the following standard:

ISO 45001 : 2018

Certificate registration no.: 9022088-014515
Date of original certification: 2019-03-10
Date of review: 2021-09-03
Date of recertification: 2023-09-03
Valid until: 2025-09-03

DQS Inc. *[Signature]*

IAF

ISO 45001 : 2018

WRAS APPROVED PRODUCT

This certifies that:

AIRA EURO AUTOMATION PVT. LTD.
has had the undermentioned product(s) examined, tested and certified as being of an appropriate quality and standard as required in the Water Supply (Water Fittings) Regulations and Scottish Water Byelaws, subject to scheme requirements being met when installed.

Model Number(s):

"ECO (WAFFER TYPE) RANGE OF BUTTERFLY VALVES: DN16-300"
DFW (DOUBLE FLANGE) RANGE OF BUTTERFLY VALVES: DN16-300"
FLB (LUG TYPE) RANGE OF BUTTERFLY VALVES: DN16-300"

The certificate is valid to the address of valid WRAS Approval. Continuation of the current status of an approval must be obtained from the WRAS Approval Directory (www.wras.co.uk/)

The product so mentioned will be valid until the end of:

April 2022
Certificate No.: 2304346
[Signature]
WRAS Approval Manager

ISO 45001 : 2018

Bureau Veritas Certification

AIRA EURO AUTOMATION PVT. LTD.

Plot No. 125-126, Aira Estate, BHM Security Estate, Near Kashmir Textile Mill, Ahmedabad - 382 405, Gujarat, India

Bureau Veritas Certification Holding S.A.S. UK Branch declares that the Management System of the above organization has been audited and found to be in accordance with the requirements of the Management System Standard stated below:

ISO 9001:2015
Scope of Certification:

DESIGN, MANUFACTURE & DISPATCH OF ACTUATORS, BALL VALVES, BUTTERFLY VALVES, CONTROL VALVES, PRESSURE REDUCING VALVES, ELECTRO-PNEUMATIC VALVES, SOL ENDO VALVES, PLUG VALVES, VALVES ACTUATOR & AUTOMATION PRODUCTS, SOLENOID COILS, LIMIT SWITCHES AND POSITIONERS.

Original audit date: 20 January 2022
Recertification audit date: 12 January 2023
Signed by the certified representative of the organization's Management System, this certificate expires on: 27 January 2026
Certificate No.: 9022088-00000001 Version: 1 Issue date: 12 January 2023

[Signature]

ISO 9001 : 2015



CERTIFICATIONS

APPROVALS



QMS (Quality Management System)

ISO 9001 : 2015

EMS (Environment Management System)

ISO 14001 : 2015

OHSAS (Occupational Health & Safety Management System)

ISO 45001 : 2018

IBR
 PISTON VALVE
 GLOBE CONTROL VALVE (CKD/CND)
 DISC CHECK VALVE (DCV)
 PRESSURE REDUCING VALVE (PRV)
 POP TYPE SAFETY VALVE
 BALL VALVE

Pneumatic Actuator

CE /
 ATEX /
 EXIDA SIL-3 /
 PROOF OF DESIGN

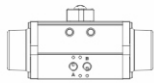

Scotch & Yoke Actuator

CE / ATEX / SIL-3

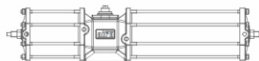

Stainless Steel Actuator

CE /
 IEP ATEX

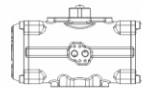

Positioner Enclosure

CE / CIMFR /
 IP67 / BIS
 / PESO

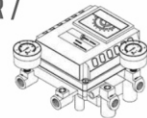

aira's
SOME OF OUR
Certificates

Plug Valve

FUGITIVE EMISSIONS
 TEST
 AS PER ISO
 15848-1 / IBR

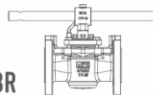

Flameproof Solenoid Valve

IEP ATEX / CE / CIMFR
 / IP65/ IP67 / IP68 /
 BIS / PESO



Limit Switch

IEP ATEX / CE / CIMFR
 / IP67 / BIS / PESO /
 EQDC IP68

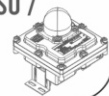

Ball Valve (Floating & Trunnion)

FIRE SAFE TEST DESIGN /
 FUGITIVE EMISSIONS TEST
 AS PER ISO 15848-1 / CE /
 PED /
 EXIDA SIL-3

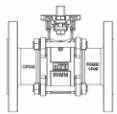

Butterfly Valve (centric / Double & Triple Eccentric)

FIRE SAFE TEST DESIGN /
 FUGITIVE EMISSIONS TEST
 AS PER ISO 15848-1 / CE /
 PED / EXIDA SIL-3
 / IBR / PROOF OF DESIGN /
 FOOD GRADE / BIS / ISI



Multiport Ball Valve

FUGITIVE EMISSIONS TEST
 AS PER ISO 15848-1 / CE /
 PED / EIL

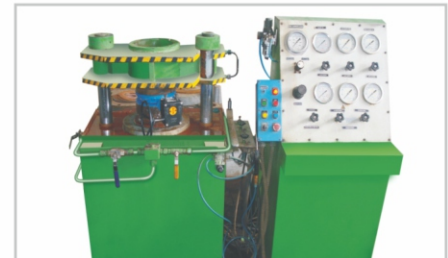
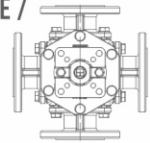

HBA HIGH PRESSURE EXPLODED BALL VALVE

15MM TO
25MM

OPERATING VARIANTS :

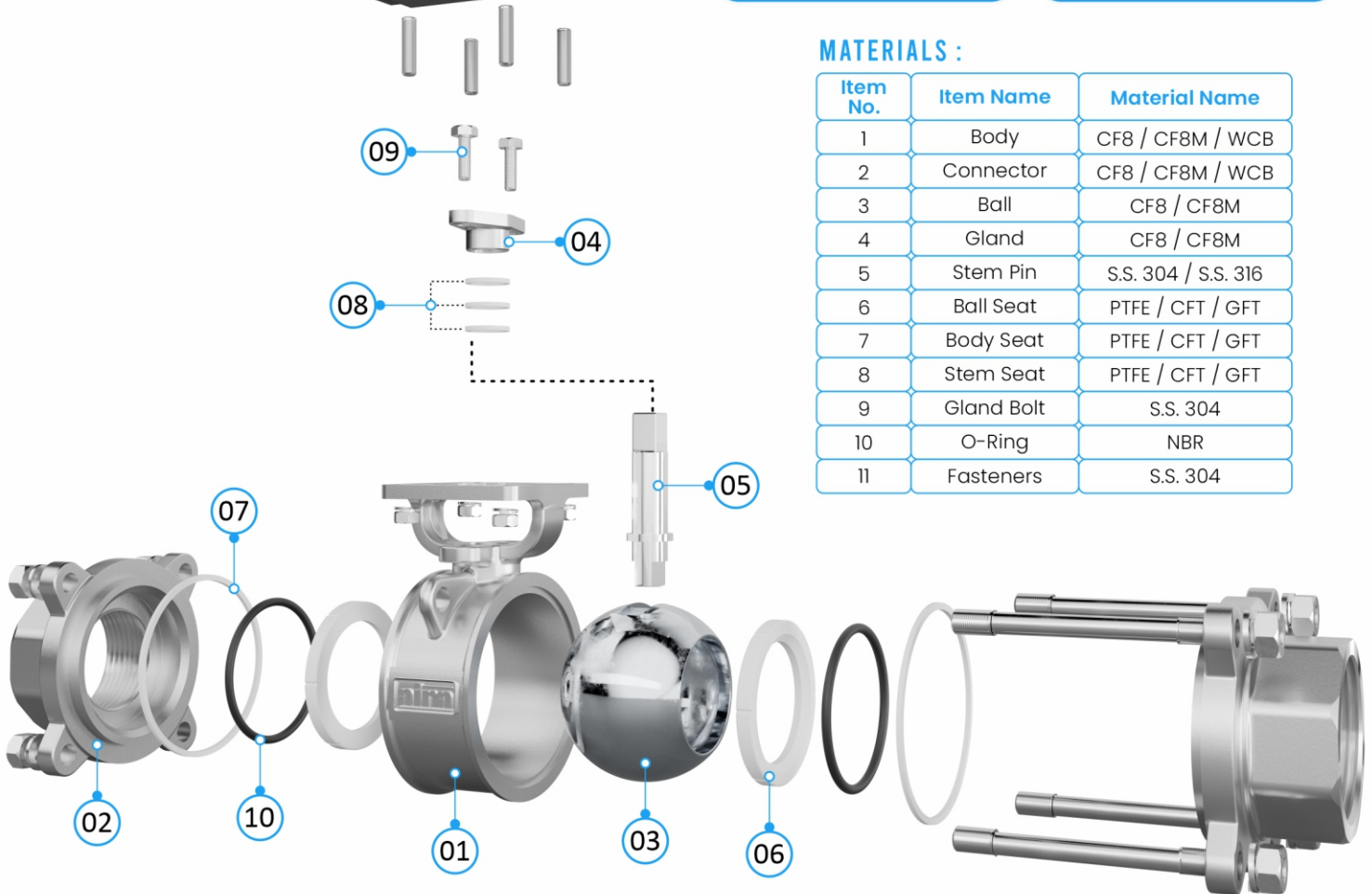

MATERIALS :

Item No.	Item Name	Material Name
1	Body	CF8 / CF8M / WCB
2	Connector	CF8 / CF8M / WCB
3	Ball	CF8 / CF8M
4	Gland	CF8 / CF8M
5	Stem Pin	S.S. 304 / S.S. 316
6	Ball Seat	PTFE / CFT / GFT
7	Body Seat	PTFE / CFT / GFT
8	Stem Seat	PTFE / CFT / GFT
9	Gland Bolt	S.S. 304
10	O-Ring	NBR
11	Fasteners	S.S. 304

HBA HIGH PRESSURE EXPLODED BALL VALVE

32MM TO
80MM



OPERATING VARIANTS :

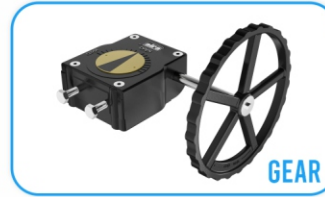

MATERIALS :

Item No.	Item Name	Material Name
1	Body	CF8 / CF8M / WCB
2	Connector	CF8 / CF8M / WCB
3	Ball	CF8 / CF8M
4	Stem Pin	S.S. 304 / S.S. 316
5	Ball Seat	PTFE / CFT / GFT
6	Body Seat	PTFE / CFT / GFT
7	Stem Seat	PTFE / CFT / GFT
8	Metal Seat	S.S. 304
9	Spacer Ring	S.S. 304
10	Stem Nut	S.S. 304
11	Bracket	S.S. 304
12	Fasteners	S.S. 304

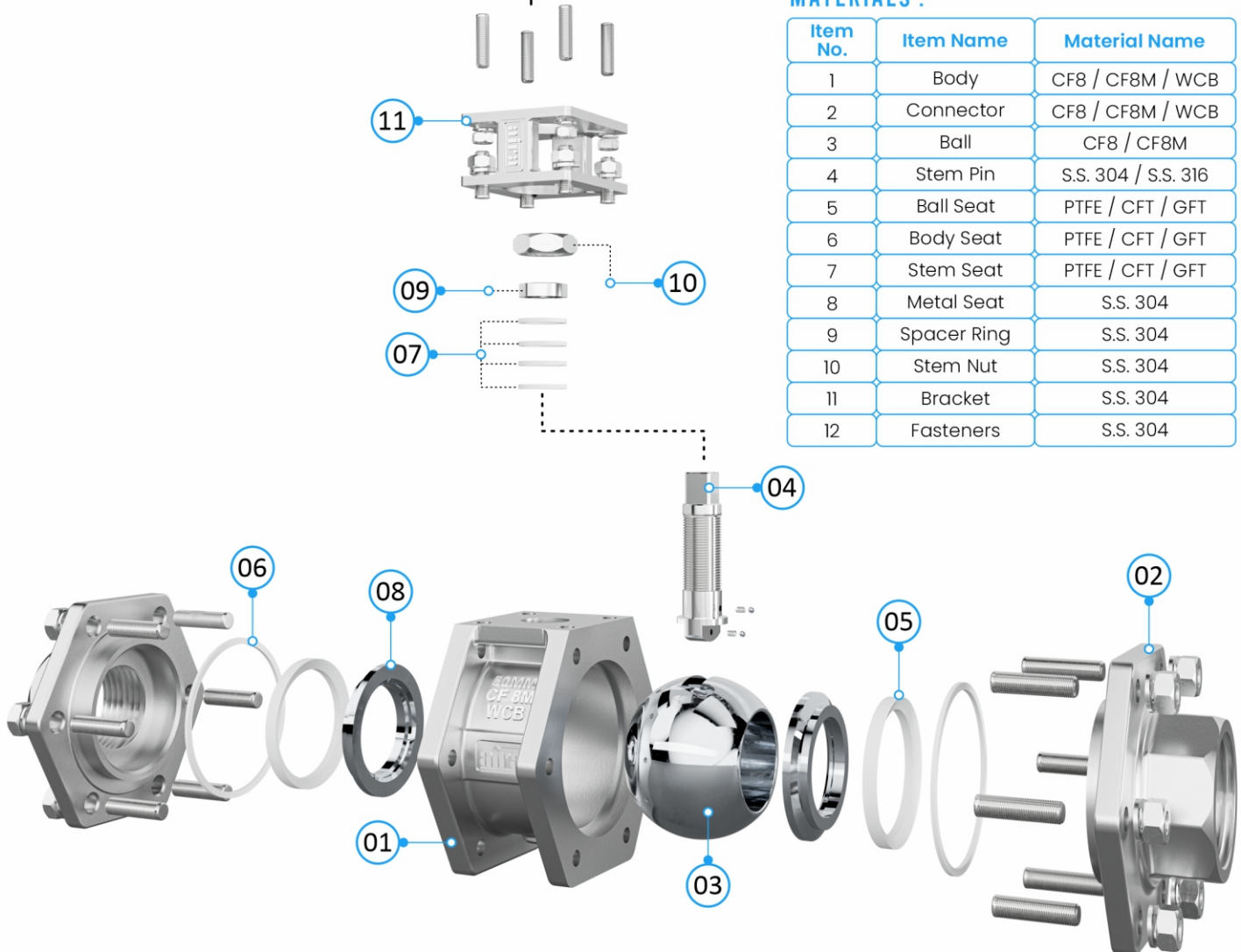

HBA HIGH PRESSURE BALL VALVE



“aira” Offers Automation & Manually Operated Investment Casting WCB / CF8 / CF8M / CF3M Floating Ball Valve In Three Piece Design. Engineered For On / Off Operations In The Down Stream.

Standard

- **Design & Manufacturer** : ASME B 16.34 / BS EN ISO 17292
- **Valve Face To Face Dimensions** : As Per Manufacturer Standard
- **Threader Fitting** : ASME B 1.20
- **Inspection And Testing** : API 598 / ISO - 5208 / BS EN 12266 - 1
- **Leakage Class** : Class VI ISO - 5208

SIZE RANGE 1/2" UPTO 3" SCREWED

Technical Specification

- **Pressure Rating** : 15 to 32 MM - CFT - 150 Kg/cm²
40 to 80 MM - PEEK - 150 Kg/cm²
40 to 80 MM - CFT - 70 Kg/cm²
- **Seat** : CFT, PEEK
- **Temperature** : As Per Seat

Features

- Fully Compliant To ASME B16.34 & API 608.
- ISO 5211 Mounting Pad Bolt Pattern.
- Slot Vented Ball For Thermal Expansion.
- Anti Static Grounded Ball & Stem.
- Blowout Proof Stem Design.
- Also Manufacture In Special Grade MOC Like Supen Duplex, Hast Alloy Etc.
- Ball Seal: CFT, PEEK.

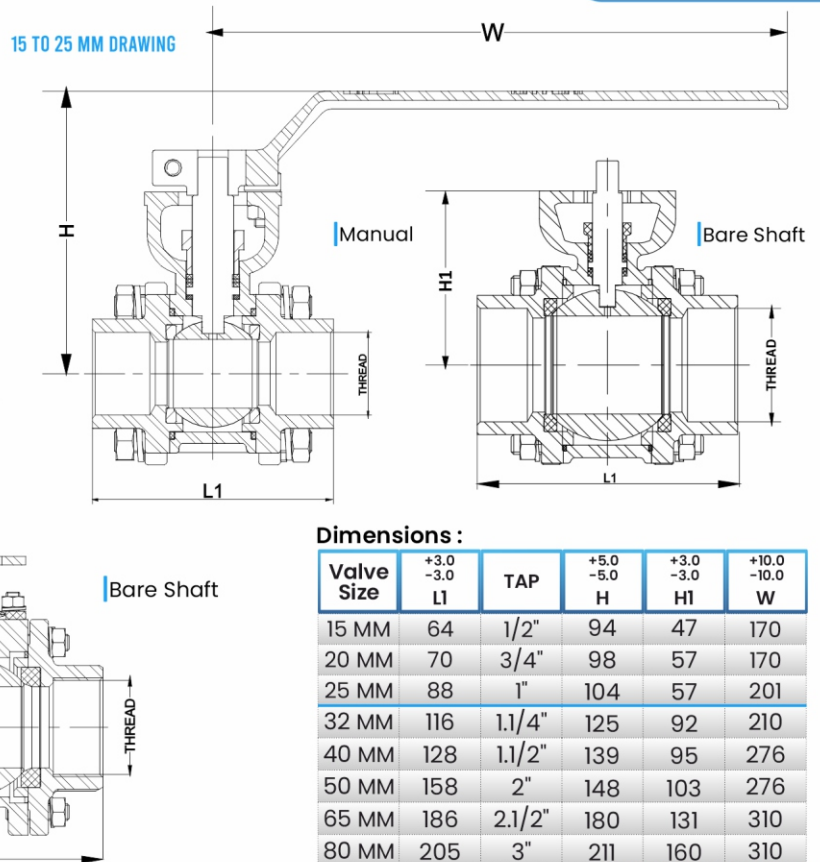
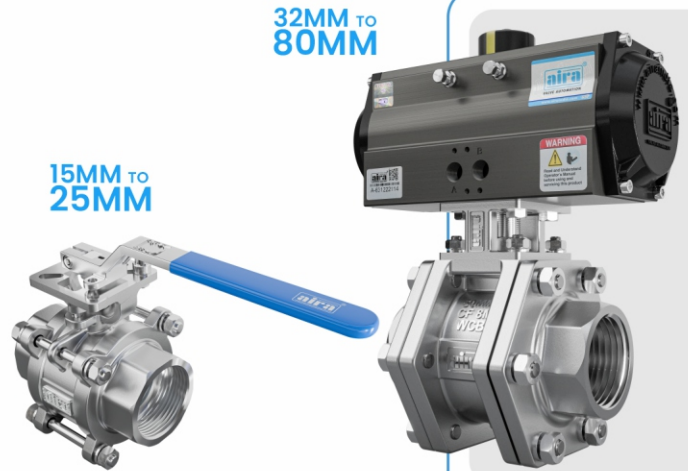

Dimensions :

Valve Size	+3.0 -3.0 L1	TAP	+5.0 -5.0 H	+3.0 -3.0 H1	+10.0 -10.0 W
15 MM	64	1/2"	94	47	170
20 MM	70	3/4"	98	57	170
25 MM	88	1"	104	57	201
32 MM	116	1.1/4"	125	92	210
40 MM	128	1.1/2"	139	95	276
50 MM	158	2"	148	103	276
65 MM	186	2.1/2"	180	131	310
80 MM	205	3"	211	160	310

*All Dimensions Are In MM



time tested designs with superior performance

GLOBAL Network



▲ International Dealers

AUSTRALIA	MALAYSIA	VIETNAM
BAHRAIN	MEXICO	NIGERIA
BANGLADESH	NEPAL	YEMEN
BHUTAN	OMAN	ZIMBABWE
BRAZIL	PARAGUAY	
CHILE	PERU	
COLOMBIA	PHILIPPINES	
ECUADOR	QATAR	
EGYPT	RUSSIA	
FIJI	SINGAPORE	
INDONESIA	SOUTH AFRICA	
IRAN	SRI LANKA	
IRAQ	TAIWAN	
IRELAND	TANZANIA	
ITALY	TURKEY	
JORDAN	UAE	
KAZAKHSTAN	UGANDA	
KENYA	UK	
KSA	USA	
MALAWI	UZBEKISTAN	





industrial valve automation

Network

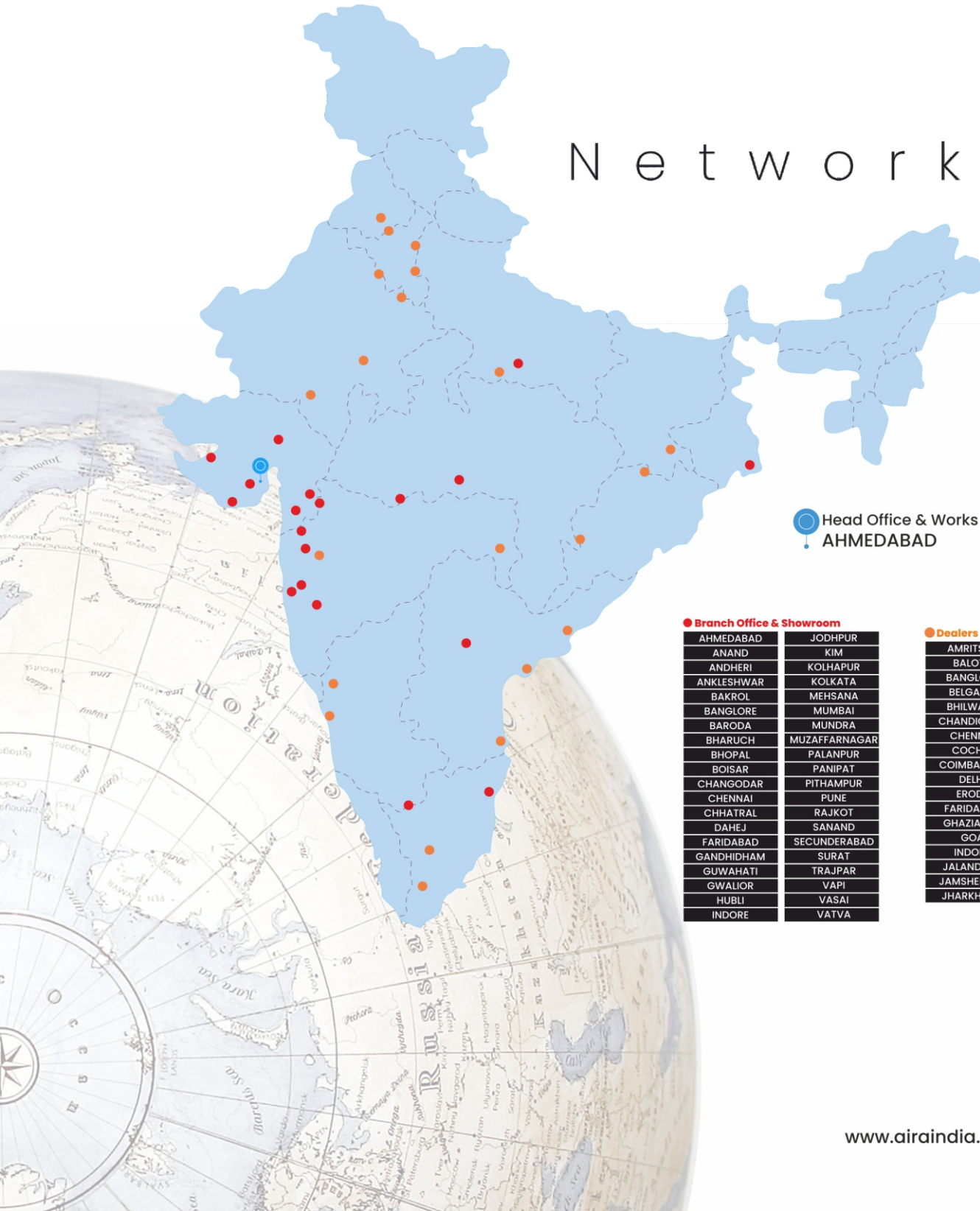

● Head Office & Works
AHMEDABAD

● Branch Office & Showroom

AHMEDABAD	JODHPUR
ANAND	KIM
ANDHERI	KOLHAPUR
ANKLESHWAR	KOLKATA
BAKROL	MEHSANA
BANGLORE	MUMBAI
BARODA	MUNDRA
BHARUCH	MUZAFFARNAGAR
BHOPAL	PALANPUR
BOISAR	PANIPAT
CHANGODAR	PITHAMPUR
CHENNAI	PUNE
CHHATRAL	RAJKOT
DAHEJ	SANAND
FARIDABAD	SECUNDERABAD
GANDHIDHAM	SURAT
GUWAHATI	TRAJPAR
GWALIOR	VAPI
HUBLI	VASAI
INDORE	VATVA

● Dealers & Distributors

AMRITSAR	KOLKATA
BALOTA	LUCKNOW
BANGLORE	LUDHIANA
BELGAUM	MARWAR
BHILWARA	MEERUT
CHANDIGARH	MUZAFFARNAGAR
CHENNAI	NAGPUR
COCHIN	NOIDA
COIMBATORE	PANIPAT
DELHI	PEENYA
ERODE	PUNE
FARIDABAD	TRIPUR
GHAZIABAD	VARANASI
GOA	VISAKHAPATNAM
INDORE	WADI
JALANDHAR	KANPUR
JAMSHEDPUR	KOLHAPUR
JHARKHAND	

HBA HIGH PRESSURE Ball Valve



Mfg. & Mkt by :

aira Euro automation pvt. ltd.

Ahmedabad-382405, INDIA.

www.airaindia.com

